

IGBT with optional Diode

IXDP 35N60 B
IXDH 35N60 B
IXDH 35N60 BD1

$V_{CES} = 600\text{ V}$
 $I_{C25} = 60\text{ A}$
 $V_{CE(sat) typ} = 2.1\text{ V}$

High Speed,
Low Saturation Voltage

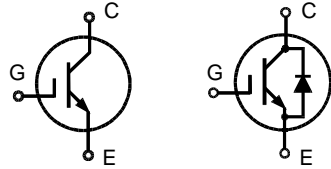

IXDH 35N60 B IXDH 35N60 BD1
IXDP 35N60 B

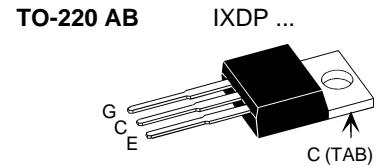
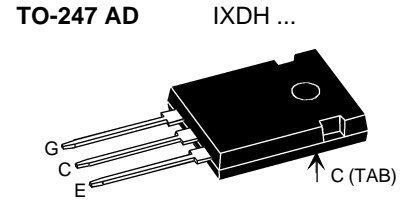

G = Gate,
C = Collector ,
E = Emitter
TAB = Collector

Symbol	Conditions	Maximum Ratings	
V_{CES}	$T_J = 25^\circ\text{C to } 150^\circ\text{C}$	600	V
V_{CGR}	$T_J = 25^\circ\text{C to } 150^\circ\text{C}; R_{GE} = 20\text{ k}\Omega$	600	V
V_{GES}	Continuous	± 20	V
V_{GEM}	Transient	± 30	V
I_{C25}	$T_C = 25^\circ\text{C}$	60	A
I_{C90}	$T_C = 90^\circ\text{C}$	35	A
I_{CM}	$T_C = 90^\circ\text{C}, t_p = 1\text{ ms}$	70	A
RBSOA	$V_{GE} = \pm 15\text{ V}, T_J = 125^\circ\text{C}, R_G = 10\ \Omega$ Clamped inductive load, $L = 30\ \mu\text{H}$	$I_{CM} = 110$ $V_{CEK} < V_{CES}$	A
t_{SC} (SCSOA)	$V_{GE} = \pm 15\text{ V}, V_{CE} = 600\text{ V}, T_J = 125^\circ\text{C}$ $R_G = 10\ \Omega$, non repetitive	10	μs
P_C	$T_C = 25^\circ\text{C}$	IGBT	250 W
		Diode	80 W
T_J		-55 ... +150	$^\circ\text{C}$
T_{stg}		-55 ... +150	$^\circ\text{C}$
	Maximum lead temperature for soldering 1.6 mm (0.062 in.) from case for 10 s	300	$^\circ\text{C}$
M_d	Mounting torque	TO-220	0.4 - 0.6 Nm
		TO-247	0.8 - 1.2 Nm
Weight		6	g

Features

- NPT IGBT technology
- low switching losses
- low tail current
- no latch up
- short circuit capability
- positive temperature coefficient for easy paralleling
- MOS input, voltage controlled
- optional ultra fast diode
- International standard package

Advantages

- Space savings
- High power density

Typical Applications

- AC motor speed control
- DC servo and robot drives
- DC choppers
- Uninterruptible power supplies (UPS)
- Switch-mode and resonant-mode power supplies

Symbol	Conditions	Characteristic Values ($T_J = 25^\circ\text{C}$, unless otherwise specified)		
		min.	typ.	max.
$V_{(BR)CES}$	$V_{GE} = 0\text{ V}$	600		V
$V_{GE(th)}$	$I_C = 0.7\text{ mA}, V_{CE} = V_{GE}$	3		5 V
I_{CES}	$V_{CE} = V_{CES}$ $T_J = 25^\circ\text{C}$ $T_J = 125^\circ\text{C}$		1	0.1 mA mA
I_{GES}	$V_{CE} = 0\text{ V}, V_{GE} = \pm 20\text{ V}$			$\pm 500\text{ nA}$
$V_{CE(sat)}$	$I_C = 35\text{ A}, V_{GE} = 15\text{ V}$		2.2	2.7 V

Symbol	Conditions	Characteristic Values ($T_J = 25^\circ\text{C}$, unless otherwise specified)		
		min.	typ.	max.
C_{ies}	$V_{CE} = 25\text{ V}, V_{GE} = 0\text{ V}, f = 1\text{ MHz}$		1600	pF
C_{oes}			150	pF
C_{res}			90	pF
Q_g	$I_C = 35\text{ A}, V_{GE} = 15\text{ V}, V_{CE} = 480\text{ V}$		120	nC
$t_{d(on)}$	Inductive load, $T_J = 125^\circ\text{C}$ $I_C = 35\text{ A}, V_{GE} = \pm 15\text{ V},$ $V_{CE} = 300\text{ V}, R_G = 10\ \Omega$		30	ns
t_r			45	ns
$t_{d(off)}$			320	ns
t_f			70	ns
E_{on}			1.6	mJ
E_{off}		0.8	mJ	
R_{thJC}				0.5 K/W
R_{thCH}	TO 247 Package with heatsink compound		0.25	K/W
R_{thCH}	TO 220 Package with heatsink compound		0.5	K/W

Symbol	Conditions	Characteristic Values ($T_J = 25^\circ\text{C}$, unless otherwise specified)		
		min.	typ.	max.
V_F	$I_F = 35\text{ A}, V_{GE} = 0\text{ V}$ $I_F = 35\text{ A}, V_{GE} = 0\text{ V}, T_J = 125^\circ\text{C}$		2.1 1.6	V V
I_F	$T_C = 25^\circ\text{C}$ $T_C = 90^\circ\text{C}$			45 A 25 A
I_{RM}	$I_F = 15\text{ A}, -di_F/dt = 400\text{ A}/\mu\text{s}, V_R = 300\text{ V}$		13	A
t_{rr}	$V_{GE} = 0\text{ V}, T_J = 125^\circ\text{C}$		90	ns
t_{rr}	$I_F = 1\text{ A}, -di_F/dt = 100\text{ A}/\mu\text{s}, V_R = 30\text{ V}, V_{GE} = 0\text{ V}$		40	ns
R_{thJC}				1.6 K/W

TO-247 AD Outline

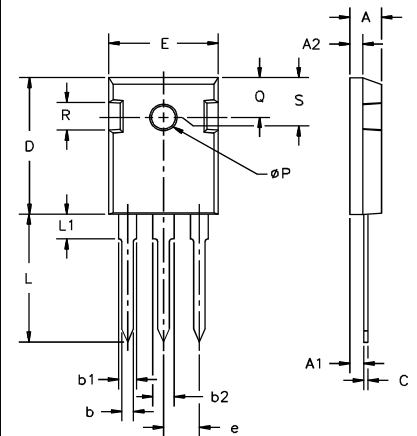

Dim.	Millimeter		Inches	
	Min.	Max.	Min.	Max.
A	4.7	5.3	.185	.209
A ₁	2.2	2.54	.087	.102
A ₂	2.2	2.6	.059	.098
b	1.0	1.4	.040	.055
b ₁	1.65	2.13	.065	.084
b ₂	2.87	3.12	.113	.123
C	.4	.8	.016	.031
D	20.80	21.46	.819	.845
E	15.75	16.26	.610	.640
e	5.20	5.72	0.205	0.225
L	19.81	20.32	.780	.800
L1		4.50		.177
∅P	3.55	3.65	.140	.144
Q	5.89	6.40	0.232	0.252
R	4.32	5.49	.170	.216
S	6.15	BSC	242	BSC

TO-220 AB Outline

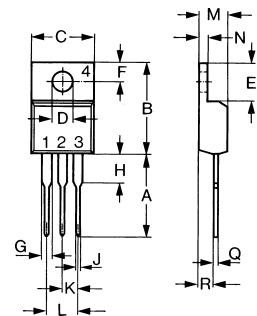

Dim.	Millimeter		Inches	
	Min.	Max.	Min.	Max.
A	12.70	13.97	0.500	0.550
B	14.73	16.00	0.580	0.630
C	9.91	10.66	0.390	0.420
D	3.54	4.08	0.139	0.161
E	5.85	6.85	0.230	0.270
F	2.54	3.18	0.100	0.125
G	1.15	1.65	0.045	0.065
H	2.79	5.84	0.110	0.230
J	0.64	1.01	0.025	0.040
K	2.54	BSC	0.100	BSC
M	4.32	4.82	0.170	0.190
N	1.14	1.39	0.045	0.055
Q	0.35	0.56	0.014	0.022
R	2.29	2.79	0.090	0.110

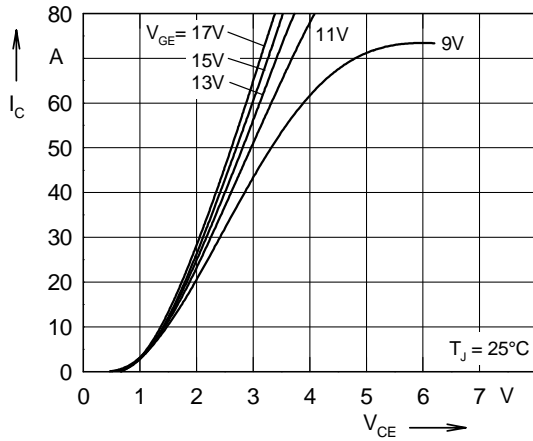

Fig. 1 Typ. output characteristics

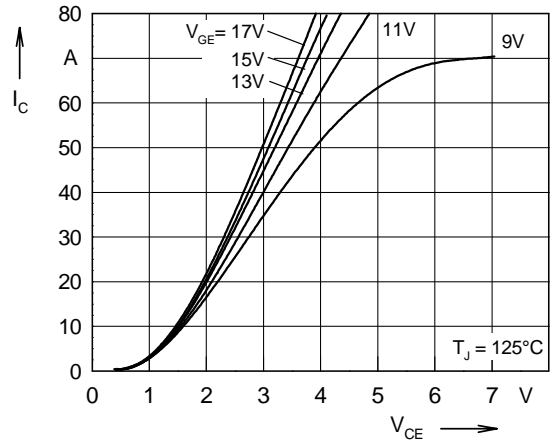

Fig. 2 Typ. output characteristics

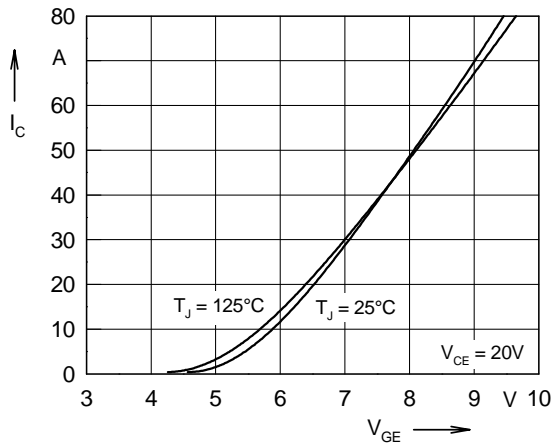

Fig. 3 Typ. transfer characteristics

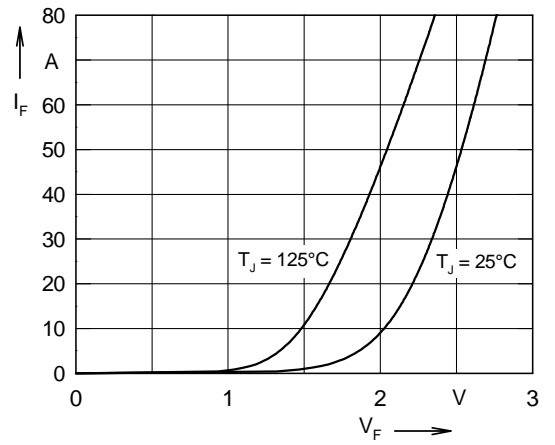

Fig. 4 Typ. forward characteristics of free wheeling diode

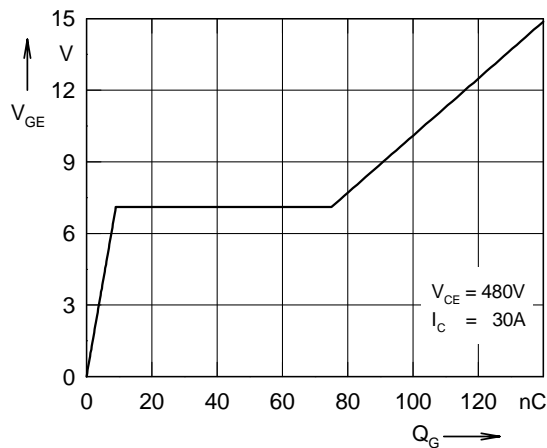

Fig. 5 Typ. turn on gate charge

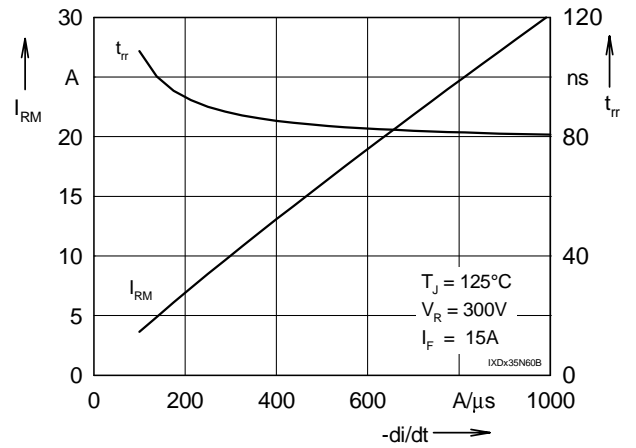

Fig. 6 Typ. turn off characteristics of free wheeling diode

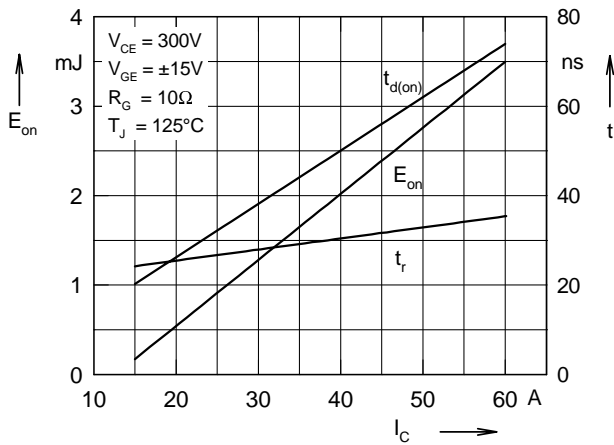

Fig. 7 Typ. turn on energy and switching times versus collector current

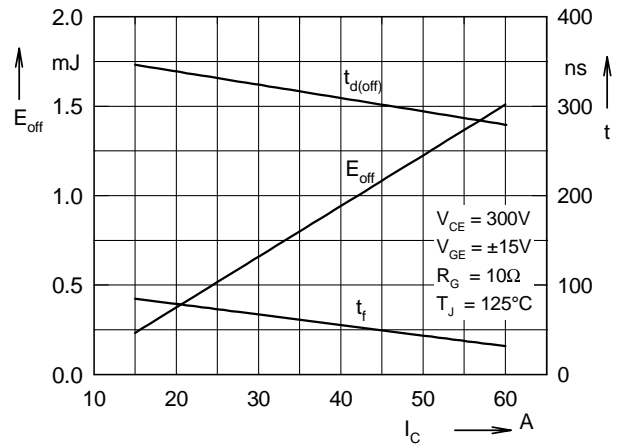

Fig. 8 Typ. turn off energy and switching times versus collector current

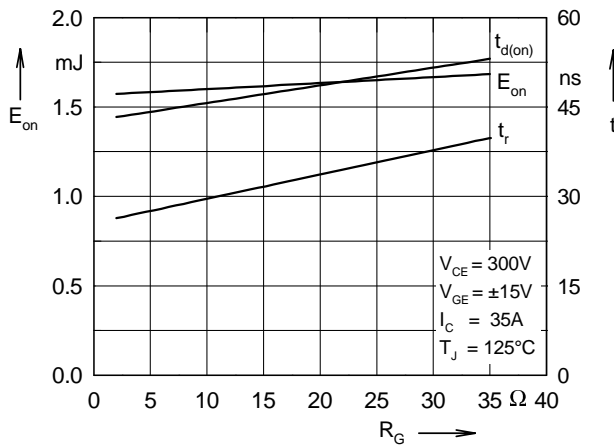

Fig. 9 Typ. turn on energy and switching times versus gate resistor

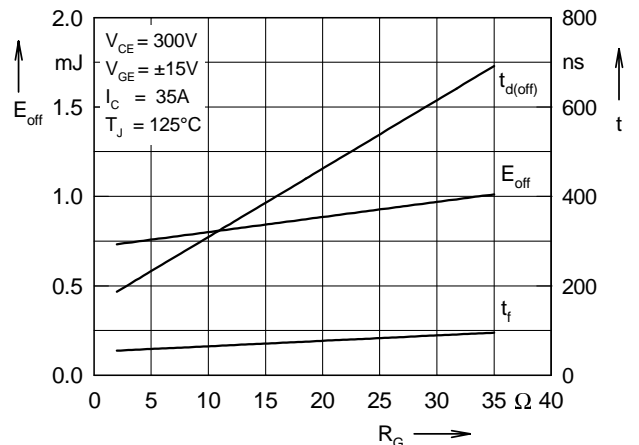

Fig.10 Typ. turn off energy and switching times versus gate resistor

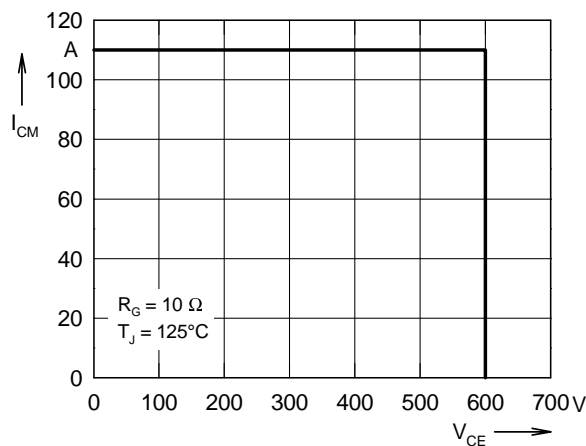

Fig. 11 Reverse biased safe operating area RBSOA

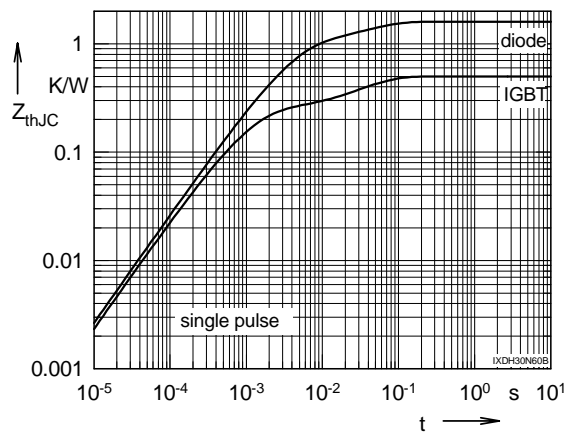

Fig. 12 Typ. transient thermal impedance